

The AUDAC Platform
Integrated audio, simplified



Integrated audio, simplified

The AUDAC Ecosystem

We take the complexity out of integrated audio, while delivering a level of control and sound performance that goes beyond what is typically expected from an integrated platform. From background music to powerful installed sound, everything runs on a single, scalable solution that is easy to deploy and manage.

This gives integrators and end-users one consistent ecosystem across every project and environment.



Design, configure & control

Why choose the AUDAC Ecosystem?



One solution for sources, processing, control, and loudspeakers



Designed for every application, from ambient music to high-output sound systems



Electronics interoperate across the entire portfolio



Works in both networked and standalone installations



We design our solutions to help you create an experience
High quality loudspeakers to ...

Improve
productivity



Public Address
Solutions

Give your brand
a voice



Premium Sound
Solutions

The possibilities are endless...



Ensure maximum
performance



Performance Sound
Solutions



The AUDAC Ecosystem or AUDAC Platform? The choice of electronics is yours



Atellio family

Networked sound & control

Networked audio and control solution with Dante integration for seamless digital audio distribution and centralized management.



Consenso family

Networked control

Flexible audio platform with networked control and analog audio paths, offering scalable systems without Dante audio networking.



Soveno family

Non-networked sound & control

Purely analog audio solution with straightforward control and signal flow, ideal for classic installations and simplicity.

The AUDAC Ecosystem

The AUDAC Platform



The AUDAC Platform

Simplified design, management & system control platform

AUDAC strongly believes in out-of-your-pocket controllable audio solutions and further establishes its progressive position by developing the AUDAC Touch™ simplified design & system control platform. Using this freely available solution, application-specific dashboards can be created and customized, allowing the control of multiple devices from one single application.



One platform for design, configuration, and control



Free to use software, available across all major OS



Feature-based licensing instead of hardware replacement



Create multi-device control dashboards in minutes



Flexible or pre-configured architecture for any environment



Quick to learn, fast to deploy



Each device works stand-alone & becomes more powerful



Seamless in- and outbound third-party integration



* Note that your national legislation may be different for your territory, check the website for more information.



User-friendly control dashboards For end users

Imagine full control over your AV system from the palm of your hand. A user-friendly interface allows you to quickly switch between audio sources and adjust the volume to create the perfect atmosphere for any occasion.

Whether you're in a restaurant, hotel, or conference center, AUDAC Touch™ makes it easy to manage not only your audio system, but also third-party devices like beamers, lights or every device that is controllable over the network.

- ✓ Available on all major OS platforms
- ✓ Intuitive full system overview
- ✓ Easy controllability of your entire installation
- ✓ Non-AUDAC products control (third-party support)
- ✓ Licensed streaming (Spotify™ and Soundtrack Your Brand©)



Design, management & control For integrators

As an integrator, you know that the success of any audio installation depends on your ability to control and manage the system with ease and precision. That's where AUDAC Touch™ comes in, offering intuitive control over AUDAC solutions and third-party equipment.

Easily design, manage & control your entire AV installation, and fine-tune the equalizer settings to achieve the perfect sound reproduction in all kinds of applications. Set up dashboards in minutes, no complex programming skills needed.

- One platform for design, configuration and control ✓
- Quick to learn, fast to deploy ✓
- Live audio control & processing technology ✓
- Over-the-air updates ✓
- Seamless in- and outbound third-party integration ✓
- No programming skills needed ✓
- Create multi-device control dashboards in minutes with drag-and-drop widgets ✓



Hello

Atellio family



Each product is a standalone solution



One platform for design, configuration & control



Flexible & scalable software architecture



Ever-expanding features incl. add-ons



Quick to learn
Fast to deploy

 **Dante**

Dante™ & AES67
Compatible

*Networked
sound, easy.*



Centralized processing

Modularity, flexibility, and sustainability were the main criteria when starting the design process and you can see this clearly when you take a closer look at the Atellio product family. You can design a project with a central processing approach by using one of our powerful matrix processors that stands out in terms of ease of installation and great flexibility during use.

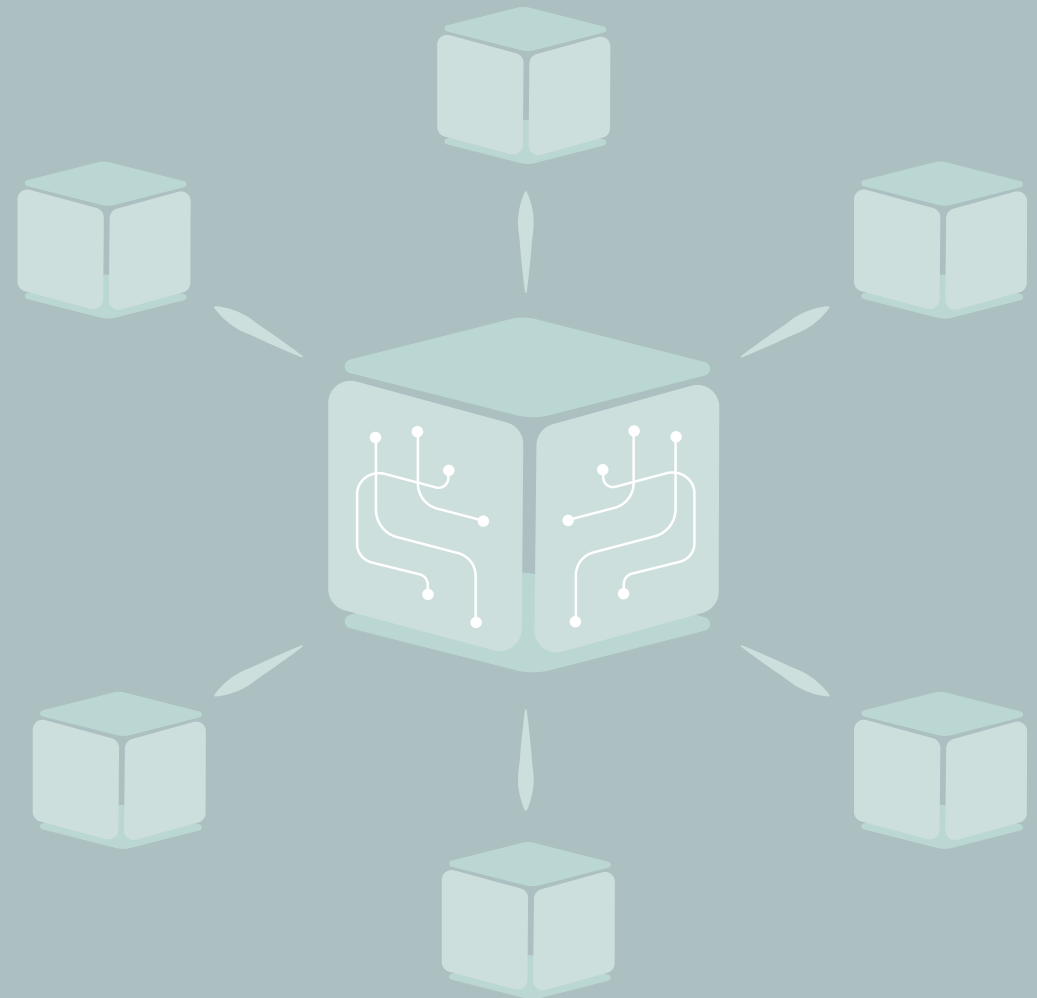

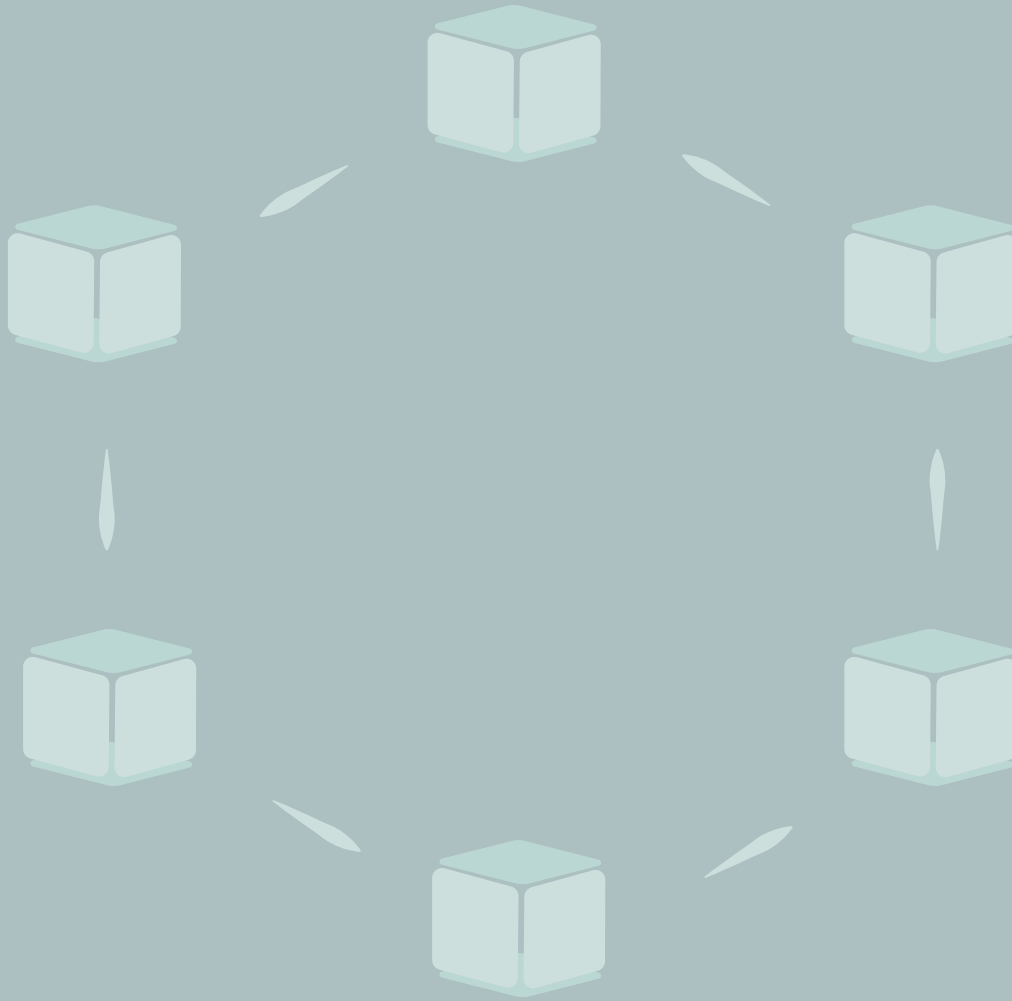

Decentralized processing

Yet you no longer must rely on a centralized approach for every solution, as every product is smarter and more powerful than before. As each member of the Atellio family has the necessary signal processing power and unique features, they are perfect for use as a stand-alone solution.





Atellio family

Centralized solution

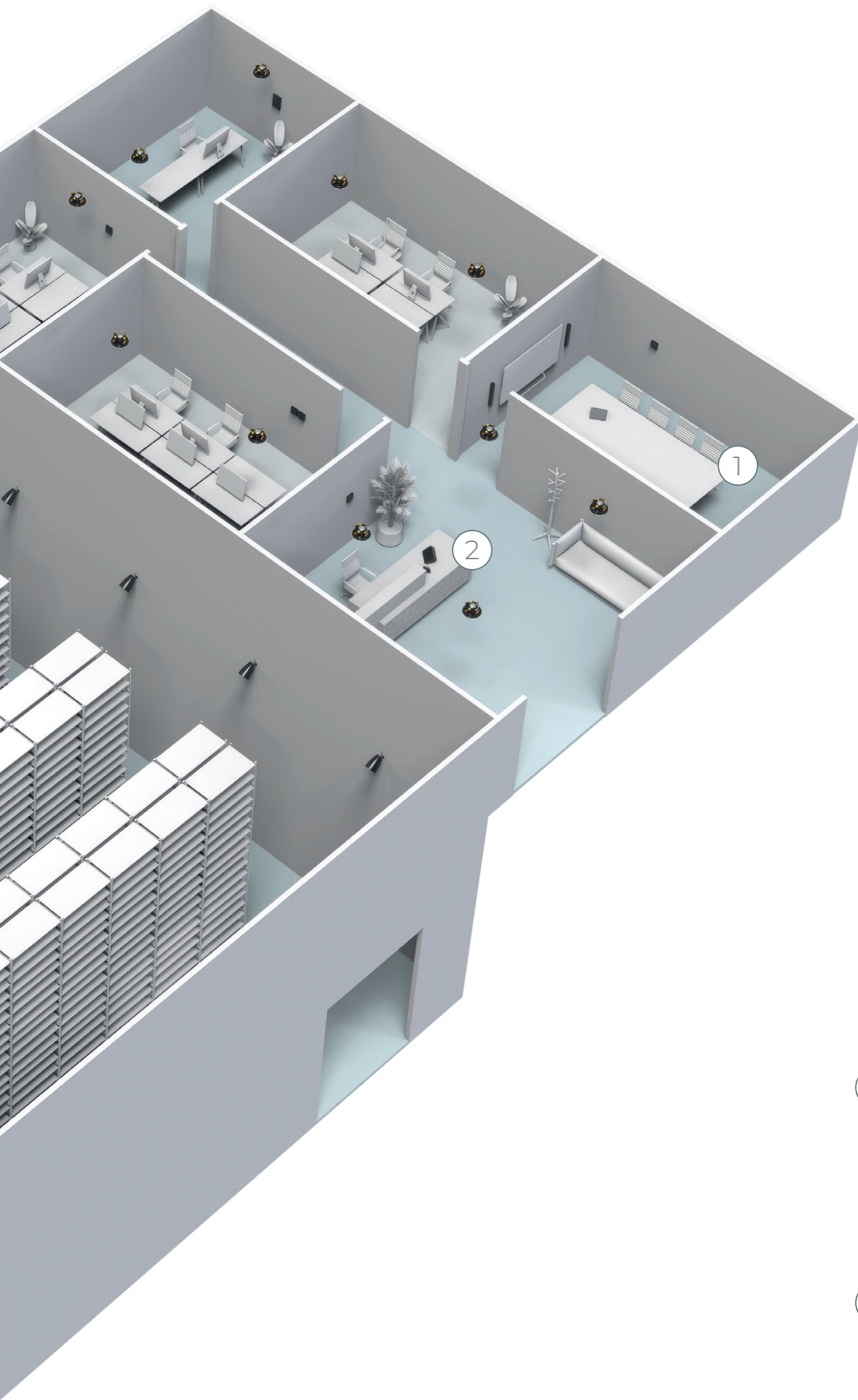

	What the user wants	What we offer	Building blocks
General requirements	<ul style="list-style-type: none"> ✓ Fast to deployment even within a large scale project ✓ Central control over all audio zones, sources & third party equipment ✓ Multi building paging & control ✓ Scalable system that grows with organisation ✓ Automatic system actions at predefined moments 	<ul style="list-style-type: none"> ✓ Full system control & configuration in one unified platform ✓ Easy to control dashboards ✓ Dante enabled solutions ✓ Modular system architecture for easy expansion ✓ Trigger and time based events such as scheduled volume changes or source switching 	<ul style="list-style-type: none"> ✓ AUDAC Touch™ ✓ RIVEA series & control panels ✓ NPM200 & Dante control panels ✓ LUNA series
1 Meeting room	<ul style="list-style-type: none"> ✓ No echo, no feedback no fiddling ✓ Flexible use of local audio sources in meeting rooms 	<ul style="list-style-type: none"> ✓ Acoustic Echo Cancellation ✓ Zone based local mixing of connected devices 	<ul style="list-style-type: none"> ✓ LUNA-F ✓ NWP series
2 Reception	<ul style="list-style-type: none"> ✓ Different control rights per user ✓ Clear priority announcements without manual system switching 	<ul style="list-style-type: none"> ✓ Role based access levels ✓ Priority handling with internal voice message playback 	<ul style="list-style-type: none"> ✓ NPM200

ZONE 1 Reception

ZONE 2 Conference room

ZONE 3 Warehouse

ZONE 4 Management

ZONE 5 Offices

ZONE 6

ZONE 7

ZONE 8

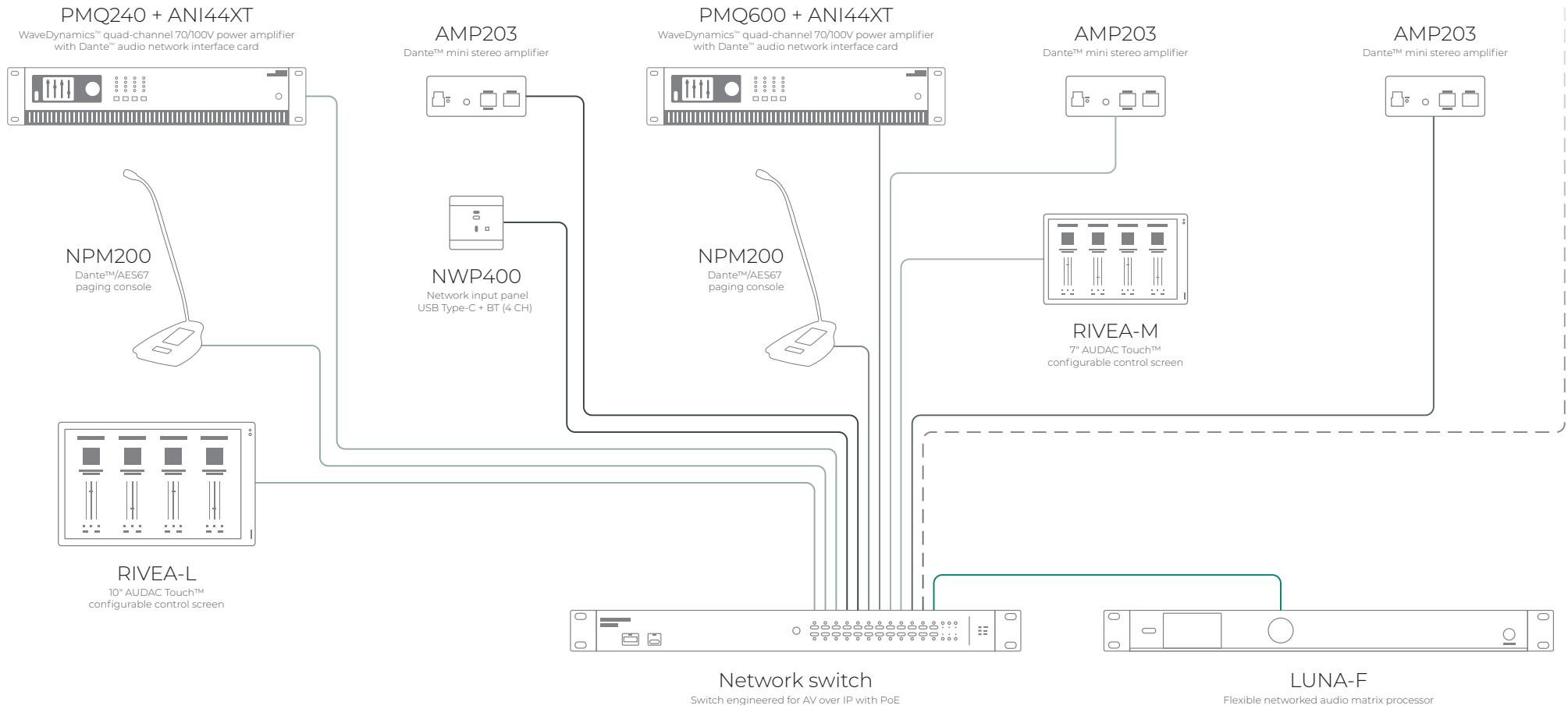



NPM200
Dante™/AES67
paging console



NWP400
Network input panel
USB Type-C + BT (4 CH)



RIVEA series
AUDAC Touch™ configurable
control screen



LUNA-F
Flexible network audio
matrix processor

Customize your dashboard with
brand logo or custom images

Surprisingly thin,
maximum elegance

System-wide control, no
central unit needed

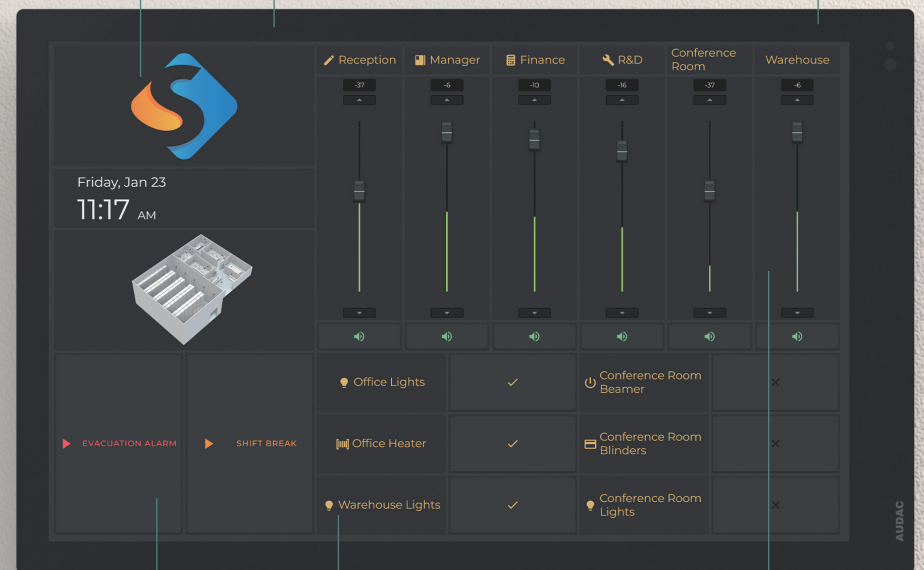

Control external AV devices via
TCP/IP commands

Control the volume level
of each zone

Play & trigger customized
voice files



Adidas Factory outlet | Berlin, Germany runs on AUDAC



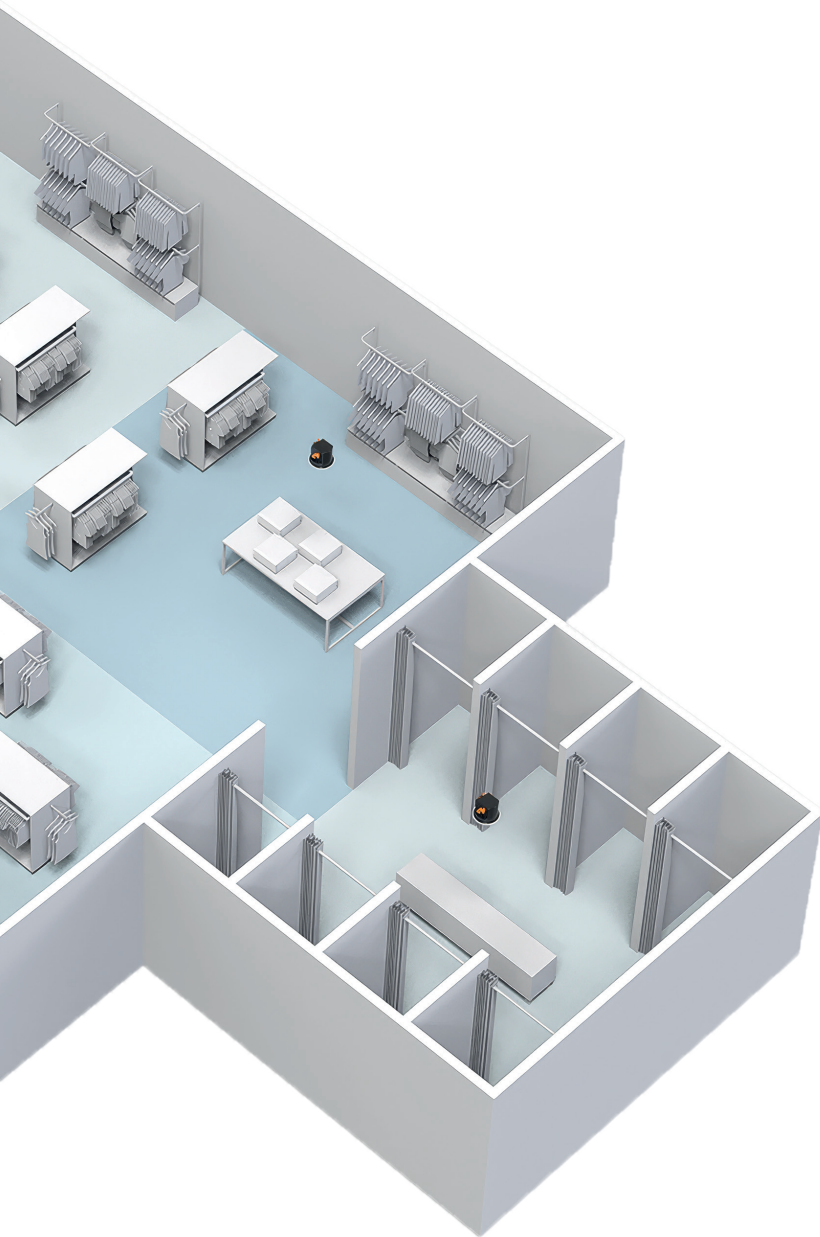

Atellio family

Decentralized virtual zones





	What the user wants	What we offer	Building blocks
General requirements	<ul style="list-style-type: none">✓ Flexible zone control without the cost and complexity of a central audio processor✓ Audio control that staff can use without training✓ A solution that scales from one store to many locations✓ A branded audio experience tailored to the store identity✓ Clear priority announcements without manual system switching	<ul style="list-style-type: none">✓ Virtual zones created through TouchLink™, linking intelligent devices into one controllable zone✓ Dedicated tactile zone control with programmable buttons per space✓ Distributed intelligence that scales per store without central dependencies✓ Customer specific music streaming integrated into the audio system✓ Priority handling with internal voice message playback without the need of a processor	<ul style="list-style-type: none">✓ MFA series & AMP203<ul style="list-style-type: none">✓ NCP105✓ TouchLink™ compatible devices<ul style="list-style-type: none">✓ NMP40✓ NPM200

ZONE 1  Reception

ZONE 2  Men

ZONE 3  Kids

ZONE 4  Women

ZONE 5  Dressing room

MFA208 + ANI44XT + NMP40

All-in-one audio solution
with Dante™ audio network interface card
& audio streaming SourceCon™ module



NPM200
Dante™/AES67
paging console



NCP105
Universal network/PoE
wall panel controller

AMP203
Dante™ mini stereo amplifier



AMP203
Dante™ mini stereo amplifier



AMP203
Dante™ mini stereo amplifier



AMP203
Dante™ mini stereo amplifier



MFA208 with ANI44XT + NMP40

All-in-one audio solution
with Dante™ audio network interface card
& audio streaming SourceCon™ module



Virtual zone



Network switch
Switch engineered for AV over IP with PoE

AUDAC Touch™
Amplify sound, simplify control





NPM200
Dante™/AES67
paging console



NCP105
Universal network/PoE
wall panel controller



MFA208 + ANI44XT + NMP40
All-in-one audio solution
with Dante™ audio network interface card
& audio streaming SourceCon™ module



AMP203
Dante™/AES67
mini stereo amplifier



Hello

Consenso family



One platform for
design, configuration
& control



Preconfigured
software
architecture



Ever-expanding
features incl. add-ons



Quick to learn
Fast to deploy



*Networked control
at your fingertips.*



Mandarin Oriental Conservatorium | Amsterdam, The Netherlands runs on AUDAC



Consenso family

Centralized solution

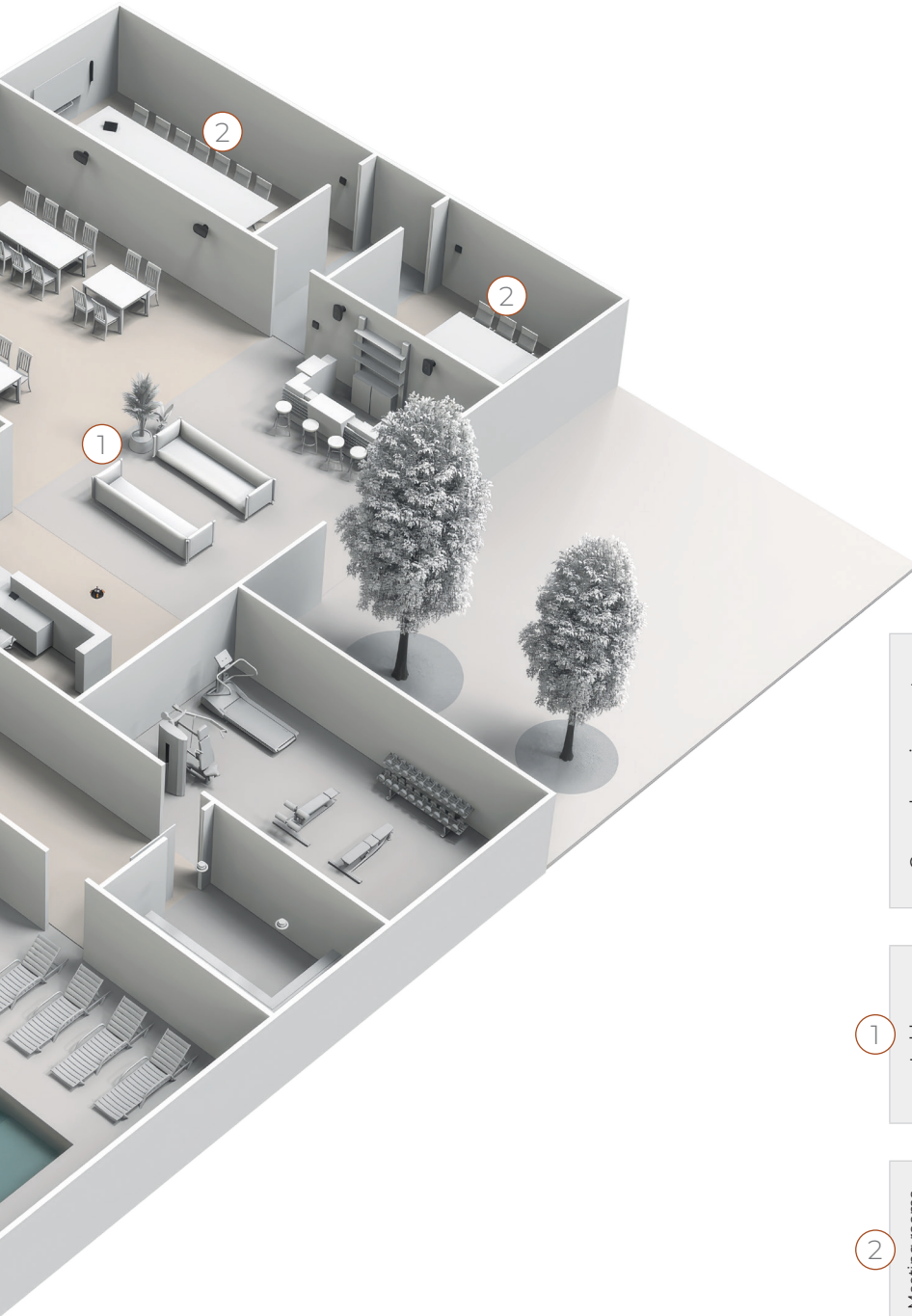

	What the user wants	What we offer	Building blocks
General requirements	<ul style="list-style-type: none">✓ Intuitive control without technical knowledge✓ A solution that fits the project requirements without over or under specification✓ Automatic actions triggered by external devices	<ul style="list-style-type: none">✓ Unified user control across zones and interfaces✓ A scalable platform that adapts to project requirements without unnecessary features✓ Integrated GPIO inputs to trigger system actions	<ul style="list-style-type: none">✓ AUDAC Touch™✓ MAIA series
1 Lobby	<ul style="list-style-type: none">✓ Audio that adapts naturally throughout the day	<ul style="list-style-type: none">✓ Time triggered events that automatically adjust audio behavior	<ul style="list-style-type: none">✓ AUDAC Touch™
2 Meeting rooms	<ul style="list-style-type: none">✓ Spaces that easily switch between different uses✓ Easy connection of laptop or mobile phone to play music	<ul style="list-style-type: none">✓ Zone based presets to adapt audio behavior to different room uses✓ Zone based local input through wall panels	<ul style="list-style-type: none">✓ WP series



MPX series
SurfaceTouch™ paging
microphones



RIVEA series
AUDAC Touch™ configurable
control screen



MAIA series
Mixing audio
matrix processors



PMQ series
WaveDynamics™ quad-channel 70/100V
power amplifiers

Customize your dashboard with
brand logo or custom images

Proximity and ambient
light detection

Sustainably built, secured
Linux OS platform

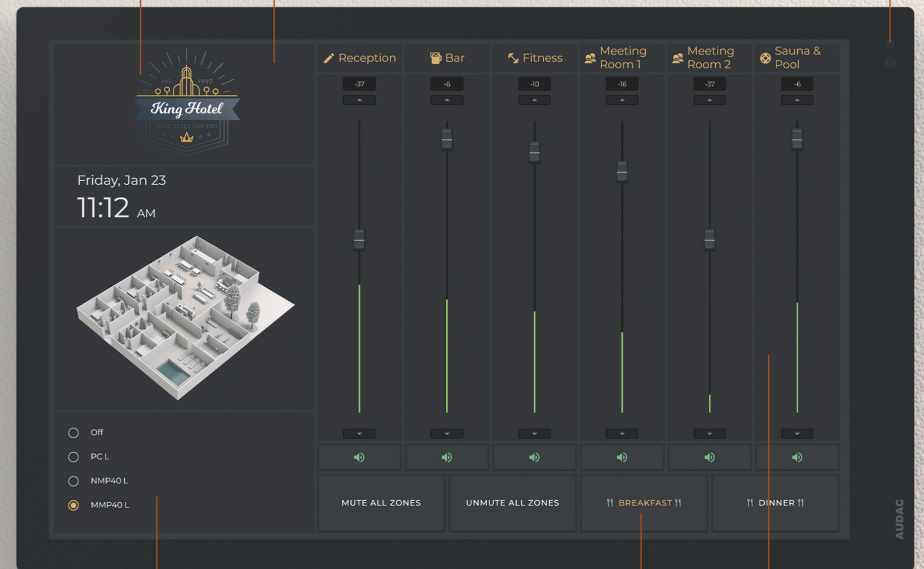

Trigger customized event

Control the volume level
of each zone

Directly change input source from
within your dashboard



A brief overview

Compare MAIA with LUNA series



MAIA series

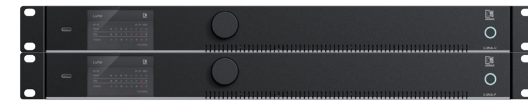

LUNA series

Installation type	Small to medium sized - From 1 up to 16 zones	Large scale projects with 16 or more zones, scaling beyond 32 zones
Architecture	Preconfigured architecture for fast deployment	Full flexible architecture for complex & scalable system designs
Routing flexibility	Flexible input-to-zone mapping	Provides full routing flexibility, including input-to-output and zone-to-output mapping
Mixing functionality	<ul style="list-style-type: none">✓ Mixing matrix with integrated processing✓ Snapshots and event handling✓ Covers essential audio processing✓ Optimized for simple setup and control	<ul style="list-style-type: none">✓ Automated processing platform for complex systems✓ Scales to large channel counts✓ LUNA-F adds advanced voice processing like: AGC, Automixing & AEC
Controlling	AUDAC Touch™ & extensive front-panel control with programmable buttons for local operation	Designed for external control via AUDAC Touch™, third-party control systems, and custom interfaces, enabling centralized and project-specific operation
Dante/AES67	Single-building	Multi-building

MAIA2 | Mixing audio matrix processor - 10 in & 2 out

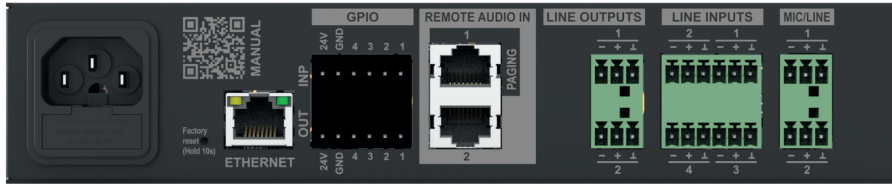

MAIA4 | Mixing audio matrix processor - 10 in & 4 out

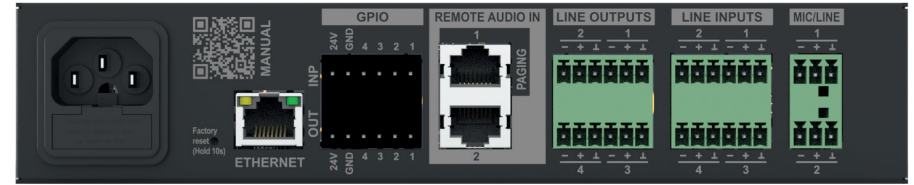

MAIA8 | Mixing audio matrix processor - 16 in & 8 out

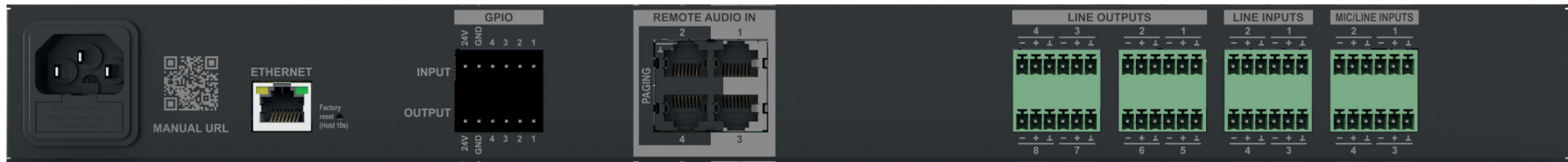

MAIA16 | Mixing audio matrix processor - 24 in & 16 out

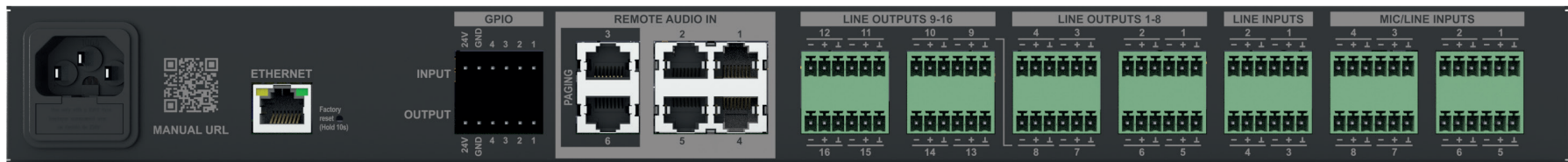

LUNA-U | Unified audio matrix processor

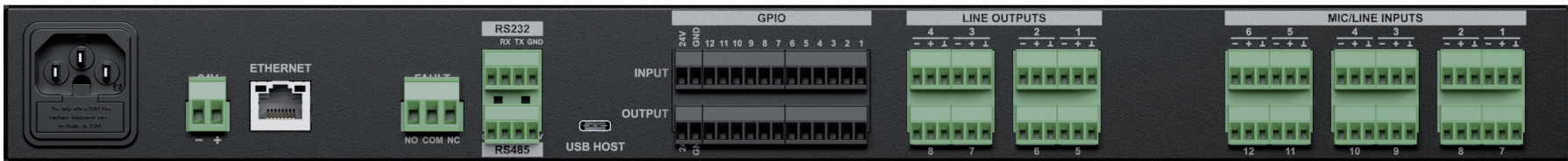

LUNA-F | Flexible network audio matrix processor

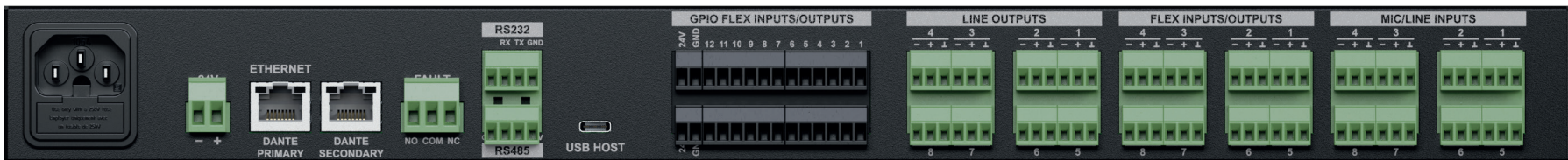

AUDAC product families

An overview - Inspired by sound



AUDAC Touch™

Network control panels

- ✓ RIVEA series
- ✓ NCP series



Atellio family

Networked sound & control

- ✓ LUNA-F
- ✓ LUNA-U + ANM88
- ✓ AMP203
- ✓ SMA, SMQ & PMQ series + ANI44XT
- ✓ MFA series + ANI44XT
- ✓ XMP series + ANX44X
- ✓ VEXO A series + ANI44XT



Consenso family

Networked control

- ✓ LUNA-U
- ✓ MAIA series
- ✓ MTX series
- ✓ ARU series
- ✓ MFA series
- ✓ XMP series



Soveno family

Non-networked sound & control

- ✓ COM series
- ✓ PRE series
- ✓ SCP, CEP & DPA series
- ✓ SMA, SMQ & PMQ series
- ✓ CAP series
- ✓ EPA series
- ✓ ISP & TSP series
- ✓ AMP22
- ✓ AGP20, ATU44 & ALI20
- ✓ VEXO A series
- ✓ ARES5A
- ✓ IMEO2

Innovative sound products

Network paging microphones

- ✓ NPM series

Network mixing panels

- ✓ NWP series

Network I/O expanders

- ✓ NIO series

Paging microphones

- ✓ MPX series (MAIA & MTX series)

Analogue wall inputs

- ✓ WP2xx, WLI, WMI & MWX65

Wall controllers

- ✓ MWX45

Paging microphones

- ✓ PDM series

Analogue wall inputs

- ✓ WP2xx series with 24V DC power supply (PSD241)

Analogue wall controllers

- ✓ WP200 & VC series

