

# IMEO2

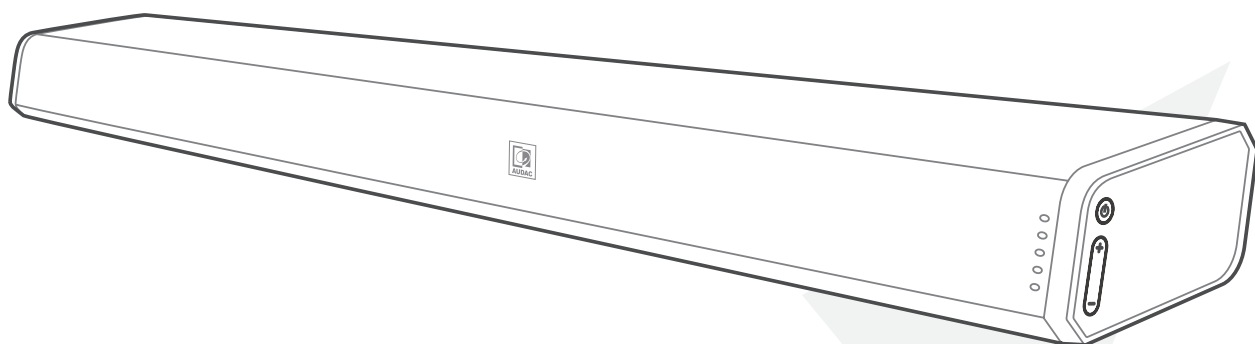

## ADDITIONAL INFORMATION

This manual is put together with much care, and is as complete as could be on the publication date. However, updates on the specifications, functionality or software may have occurred since publication. To obtain the latest version of both manual and software, please visit the Audac website @ [www.audac.eu](http://www.audac.eu).

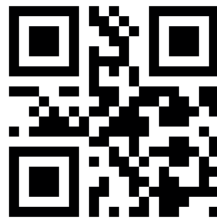

---

<b>Introduction</b>	<b>05</b>
Professional soundbar .....	05
<b>Precautions</b>	<b>06</b>
<b>Chapter 1</b>	<b>08</b>
Connections and connectors .....	08
<b>Chapter 2</b>	<b>09</b>
Overview IMEO2: Front .....	09
Overview IMEO2: Rear .....	010
Overview IMEO2: Remote control .....	011
<b>Chapter 3</b>	<b>013</b>
Placement and mounting .....	013
<b>Chapter 4</b>	<b>015</b>
Connecting .....	015
<b>Chapter 5</b>	<b>017</b>
Additional information .....	017
<b>Technical specifications</b>	<b>019</b>
<b>Notes</b>	<b>021</b>



## Professional soundbar

The IMEO2 Soundbar features a slim and elegant design and includes all required functions for expansion of any audiovisual system with an impressive sound, while having a minimal hassle for installation. It's perfectly suited for installations such as classrooms, presentation rooms or meeting rooms where it can be used and installed in combination with screens, smartboards or projectors.

The acoustics originate from a 3-way speaker construction, composed of two 1.5" high frequency drivers, two 2" mid frequency drivers and a low frequency section with two 2.5" low frequency drivers with an RMS rating. The power handling reaches an overall level of 60 Watt RMS. The Class-D amplifier with integrated WaveSelect DSP processing and transmission line configuration for the low-frequency drivers offers a crystal clear sound reproduction with stunning low-frequency response. Selectable DSP presets offer optimization for applications such as presentations, music playback or video's.

Various input possibilities such as an unbalanced line input, HDMI (ARC) input or SPDIF (optical and coaxial) allow compatibility with a variation of input sources, while Bluetooth allows wireless connections with portable devices. In installations with multiple IMEO's installed throughout the area, it can be desirable to assign custom Bluetooth ID's to distinguish them from each other. Typical applications are hotels, conference rooms, schools, ... The hotel mode function in the firmware offers a solution for these applications. An additional function is also implemented to define a specific wake-up source, allowing the IMEO2 to always turn-on with the same input source selected, no matter which input source was selected before power-down.

An included IR remote control allows input selection, volume control and EQ preset selection while the unique and clever wall mounting bracket allows convenient mounting to walls on any kind of surface or location with an optimal guiding and coverage for the cables.

The auto standby function ensures that the IMEO is automatically put in energy-saving mode after 15 minutes without input. This way, no unnecessary energy is lost, while the IMEO remains ready to play at any moment.

# Precautions



## READ FOLLOWING INSTRUCTIONS FOR YOUR OWN SAFETY

ALWAYS KEEP THESE INSTRUCTIONS. NEVER THROW THEM AWAY

ALWAYS HANDLE THIS UNIT WITH CARE

HEED ALL WARNINGS

FOLLOW ALL INSTRUCTIONS

NEVER EXPOSE THIS EQUIPMENT TO RAIN, MOISTURE, ANY DRIPPING OR SPLASHING LIQUID. AND NEVER PLACE AN OBJECT FILLED WITH LIQUID ON TOP OF THIS DEVICE

NO NAKED FLAME SOURCES, SUCH AS LIGHTED CANDLES, SHOULD BE PLACED ON THE APPARATUS

DO NOT PLACE THIS UNIT IN AN ENCLOSED ENVIRONMENT SUCH AS A BOOKSHELF OR CLOSET. ENSURE THERE IS ADEQUATE VENTILATION TO COOL THE UNIT. DO NOT BLOCK THE VENTILATION OPENINGS.

DO NOT STICK ANY OBJECTS THROUGH THE VENTILATION OPENINGS.

DO NOT INSTALL THIS UNIT NEAR ANY HEAT SOURCES SUCH AS RADIATORS OR OTHER APPARATUS THAT PRODUCE HEAT

DO NOT PLACE THIS UNIT IN ENVIRONMENTS WHICH CONTAIN HIGH LEVELS OF DUST, HEAT, MOISTURE OR VIBRATION

THIS UNIT IS DEVELOPED FOR INDOOR USE ONLY. DO NOT USE IT OUTDOORS

PLACE THE UNIT ON A STABLE BASE OR MOUNT IT IN A STABLE RACK

ONLY USE ATTACHMENTS & ACCESSORIES SPECIFIED BY THE MANUFACTURER

UNPLUG THIS APPARATUS DURING LIGHTNING STORMS OR WHEN UNUSED FOR LONG PERIODS OF TIME

ONLY CONNECT THIS UNIT TO A MAINS SOCKET OUTLET WITH PROTECTIVE EARTHING CONNECTION

THE MAINS PLUG OR APPLIANCE COUPLER IS USED AS THE DISCONNECT DEVICE, SO THE DISCONNECT DEVICE SHALL BE READILY OPERABLE

USE THE APPARATUS ONLY IN MODERATE CLIMATES

## CAUTION

The symbols shown are internationally recognized symbols that warn about potential hazards of electrical products. The lightning flash with arrow point in an equilateral triangle means that the unit contains dangerous voltages. The exclamation point in an equilateral triangle indicates that it is necessary for the user to refer to the users manual.



These symbols warn that there are no user serviceable parts inside the unit. Do not open the unit. Do not attempt to service the unit yourself. Refer all servicing to qualified personnel. Opening the chassis for any reason will void the manufacturer's warranty. Do not get the unit wet. If liquid is spilled on the unit, shut it off immediately and take it to a dealer for service. Disconnect the unit during storms to prevent damage.



### **CAUTION - SERVICING**

This product contains no user serviceable parts. Refer all servicing to qualified service personnel. Do not perform any servicing (unless you are qualified to)



### **EC DECLARATION OF CONFORMITY**

This product conforms to all the essential requirements and further relevant specifications described in following directives: 2014/30/EU (EMC) , 2014/35/EU (LVD) and 2014/53/EU (RED)



### **WASTE ELECTRICAL AND ELECTRONIC EQUIPMENT (WEEE)**

The WEEE marking indicates that this product should not be disposed with regular household waste at the end of its life cycle. This regulation is created to prevent any possible harm to the environment or human health.

This product is developed and manufactured with high quality materials and components which can be recycled and/or reused. Please dispose this product at your local collection point or recycling centre for electrical and electronic waste. This will make sure that it will be recycled in an environmentally friendly manner, and will help to protect the environment in which we all live.



### **ENERGY STAR**

This product qualifies for ENERGY STAR in the "factory default" setting and this is the setting in which power savings will be achieved. Changing the factory default settings or enabling other features will increase power consumption that could exceed the limits necessary to qualify for ENERGY STAR rating. We want to help you save energy.

## Connections and connectors

### CONNECTION STANDARDS

The in- and output connections for AUDAC audio equipment are performed according to international wiring standards for professional audio equipment

#### 1. 3.5 mm Jack (AUX):

For unbalanced line input connections

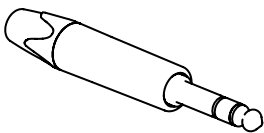

<b>Tip:</b>	Left
<b>Ring:</b>	Right
<b>Sleeve:</b>	Ground

#### 2. RCA (COAXIAL):

For coaxial SP/DIF digital input connections

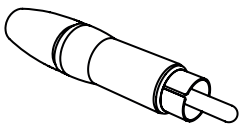

<b>Tip:</b>	Signal
<b>Sleeve:</b>	Ground

#### 3. TOSLINK (OPTICAL)

For optical SP/DIF digital input connections

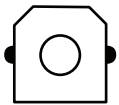

#### 3. HDMI ARC:

For HDMI (ARC) input connections



#### HDMI Type A (19-pin)

<b>Pinout:</b>	According HDMI specifications
----------------	-------------------------------

#### USB

USB-a: For playbacks and updates

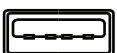



## Overview IMEO2: Front

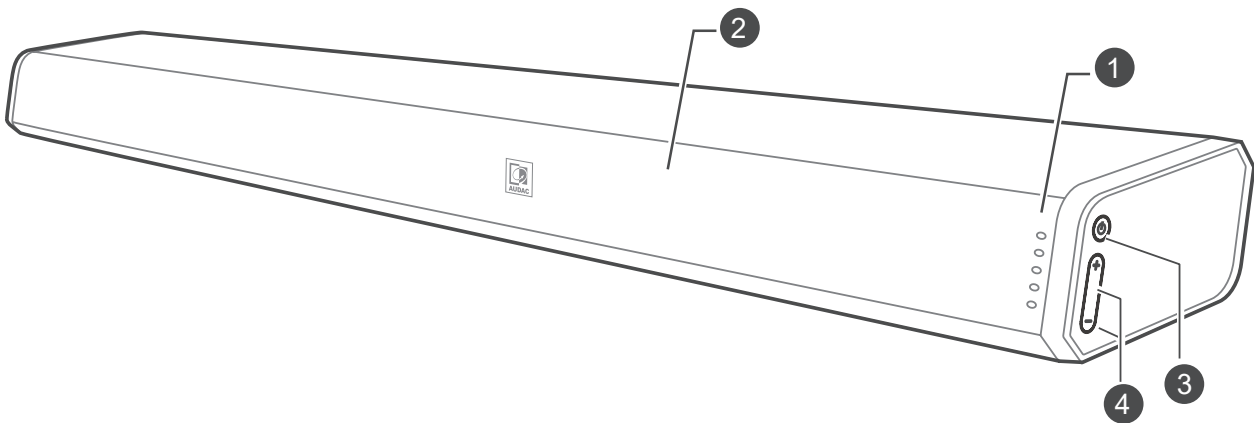

### 1) Status indicator LED's:

These LED's indicate the current operation status of the IMEO2. Various color LED's indicate following statuses:

- Red: Standby mode
- Green: (Blinking) USB / (Illuminated) AUX (3.5 mm jack input)
- Blue: Bluetooth mode
- Orange: (Illuminated) Optical / (Blinking) Coaxial mode
- White: HDMI ARC mode

### 3) Power button:

The power button allows to switch on and off the unit. Press to switch the sound bar on. Press and hold to switch the sound bar off. Repeatedly press (short term) to switch between the various operation modes

(USB / AUX / BLUETOOTH / OPTICAL / COAXIAL / HDMI ARC).

### 2) Remote control (IR) sensor:

The remote control (IR) sensor is located behind the front grill of the IMEO2. This sensor requires a line-of-sight connection with the remote control. Make sure this sensor is not covered or blocked.

### 4) +/- buttons:

The + / - buttons allow to increase or decrease the volume level.

## Overview IMEO2: Rear

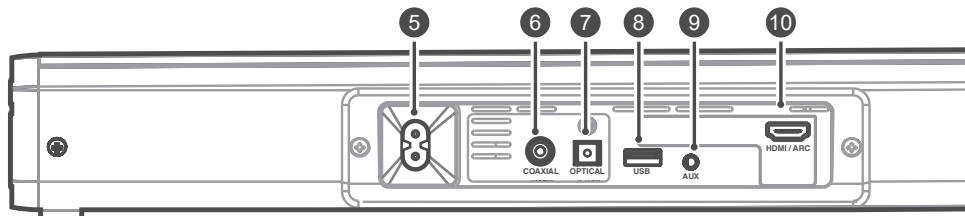

### 5) AC Power inlet connection:

The mains power supply (100-240V AC - 50/60 Hz) has to be applied to this AC power inlet. The connection is made by an IEC C8 power connector and the power lead is standard fitted, but can be unplugged for convenient assembly.

### 6) Coaxial input connection:

The coaxial input connection (RCA) allows connecting the sound bar to any TV, receiver or other source device with an coaxial SP/DIF output connection.

### 7) Optical input connection:

The optical input connection (Toslink) allows connecting the sound bar to any TV, receiver or other source device with an optical SP/DIF output connection.

### 8) USB socket:

The USB connection allows connection to memory devices. This allows previously stored audio sources to be played back (MP3, FLAC, WAV).

### 9) AUX socket:

The AUX input connection (3.5 mm jack) allows connecting the sound bar to any stereo line-level audio source. It can be a connection between a portable device such as smartphone, tablet, laptop or headphone output of any device.

### 10) HDMI ARC socket:

The HDMI input socket allows connecting the soundbar to any TV or projector with an HDMI connection supporting ARC functionality

## Overview IMEO2: Remote control

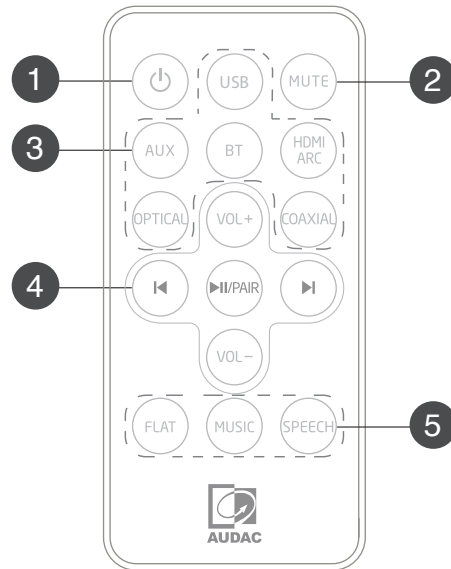

The IMEO2 includes an IR remote controller, which allows the operation of it from a distance of 6 meters.

### 1) Power button:

Switches the sound bar between ON and STANDBY mode.

### 2) MUTE button:

Toggles the status between Mute music or resume the sound.

### 3) Source buttons:

Selects the audio source between the various operation modes:

AUX / BLUETOOTH / HDMI ARC / OPTICAL / COAXIAL / USB.

### 4) Playback control buttons:

**VOL+ / VOL-** buttons: allows to increase or decrease the volume level.

**◀ / ▶** buttons: allows to skip to the previous and next tracks (only in Bluetooth and USB mode)

**▶ || / PAIR** button: Allows to play / pause / resume playback in Bluetooth and USB mode. Press and hold to activate the pairing function in Bluetooth mode or disconnect the currently paired Bluetooth device.

### 5) EQ buttons:

Allows to select a preset sound effect. Various presets are available for FLAT, MUSIC and SPEECH. The optimal flat configuration is selected when the FLAT preset (default configured), while low frequencies are added when the MUSIC preset is selected and low frequencies are reduced when selected the SPEECH preset. Select the optimal preset according to your application requirements.

## CONNECTION STANDARDS

### First time use:

The remote control has a pre-installed lithium CR2025 battery. Remove the protective tab to activate the remote control battery.

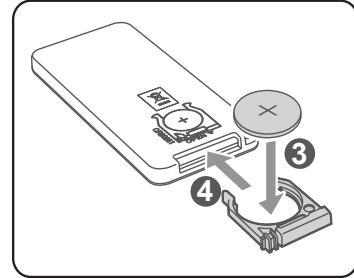
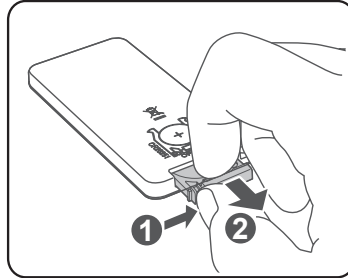
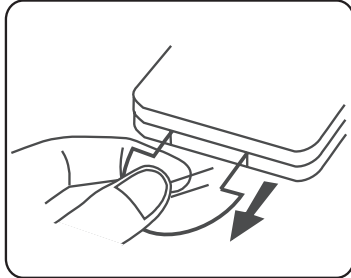

### Replace the remote control battery:

The remote control requires a CR2025, 3V Lithium battery.

### CAUTION

Do not ingest battery, danger of chemical burn. This product contains a button cell battery. If the button cell battery is swallowed, it can cause severe internal burns within 2 hours, which may even result in death. Keep new and used batteries away from children. If the battery compartment does not close properly, stop using the product and keep it away from children. If you believe that batteries have been swallowed or have been entered a body part, seek medical attention immediately.

To replace this battery, follow the steps as below:

- Push the tab on the side of the battery tray towards the tray
- Slide the battery tray out of the remote control
- Remove the old battery. Place a new CR2025 battery into the battery tray with the correct polarity as indicated
- Slide the battery tray back into the slot in the remote control

### CAUTION

If the remote control is operated near other products which generate infrared rays, or if other remote control units also using infrared rays are near the unit, it may operate incorrectly. Conversely, the other products may operate incorrectly

### Precautions Concerning Batteries:

- Then the remote control is not to be used for a long time (more than a month), remove the battery from the Remote Control to prevent it from leaking.
- If the batteries leak, wipe away the leakage inside the battery compartment and replace the batteries with new ones.
- Do not use any batteries other than those specified.
- Do not heat or disassemble batteries.
- Never throw them in fire or water.
- Do not carry or store batteries with other metallic objects. Doing so could cause batteries to short circuit, leak or explode.
- Never recharge a battery unless it is confirmed to be a rechargeable type.

## Placement and mounting

The IMEO2 offers possibilities for placement on a leveled surface underneath / in front of the TV, display or projection surface. An included mounting bracket offers possibilities for secure wall mounting, above or underneath the TV, display or projection surface.

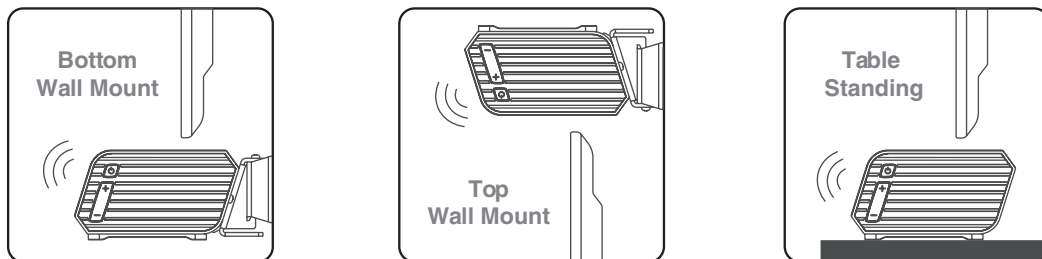

The special mounting bracket consists of a wall support bar and two fixation hooks which comes default assembled to the sound bar.

### ATTENTION

- Installation must be carried out by qualified personnel only. Incorrect assembly can result in severe personal injury and property damage (if you intend to install this product yourself, you must check for installations such as electrical wiring and plumbing that may be buried inside the wall).
- It is the installer's responsibility to verify that the wall will safely support the total load of the unit and wall brackets.
- Additional tools (not included) are required for the installation.
- Do not over tighten screws.
- Keep this instruction manual for future reference.

### 1. Attach the wall support bar

The first step is the mounting of the supplied wall support bar on the desired location on the wall. The support bar has to be fixed to the wall by four screws which need to get fitted through the provided slots. The provided slots have an elliptical shape, allowing the possibility for slightly adjusting the position to make it perfectly level.

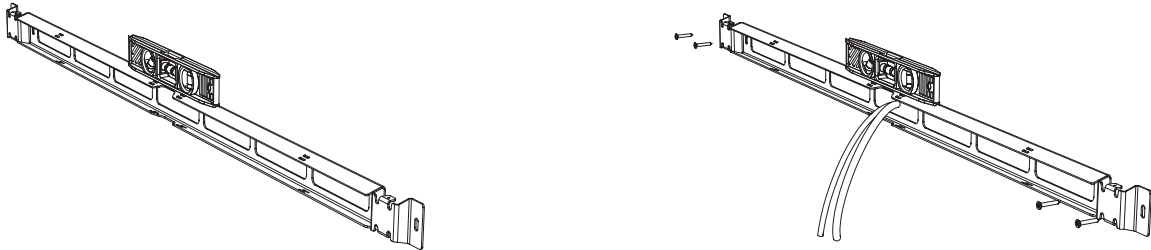

Make sure the appropriate fasteners are used, depending on the mounting surface

(brick, concrete, wood, ... )

The cables (depending of the required connections for applications) can be fed through the openings of the wall support bar, and can be tied to the fixation slots using cable ties.

### 2. Make the connections

After the wall support bar is mounted, the connections shall be made depending of the application requirements. Various connection accessories such as cables, pigtails and 90° angle parts are included for making the connection possible.

### 3. Attach the speaker

After the wall support bar is attached and the connections are made, the soundbar shall be fixed to the wall plate. This is done by sliding the hooks assembled to the soundbar into the provided slots on the wall support bar and fixing them.

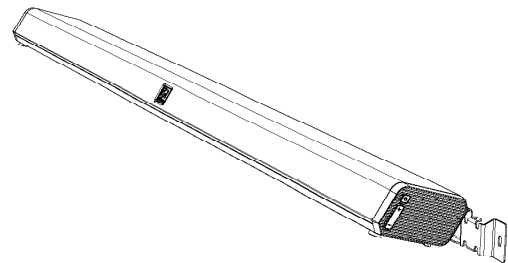

### 4: Fixating the speaker

#### 4.A) TOP security bolt:

This option can be selected in the situation that no object is placed above the IMEO2. To prevent the IMEO2 from falling, attach safety screws on top of the fixing hooks.

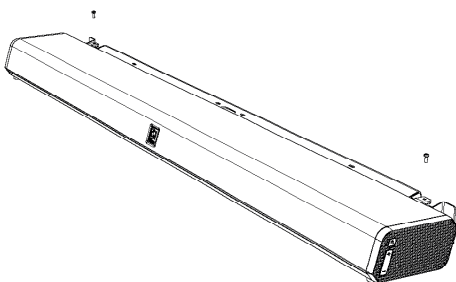

#### 4.B) BOTTOM security bolt:

There is the option of fixing the speaker from below when an object is placed above of the IMEO2. Attach the custom safety screws at the bottom of the fixing hooks.

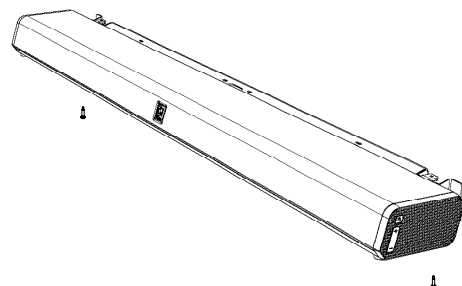

## Connecting

### Using the HDMI (ARC) socket

The ARC (Audio Return Channel) function allows you to send audio from your ARC compliant TV to your sound bar through a single HDMI link. To enjoy the ARC function, please ensure your TV is both HDMI CEC and ARC compliant and set up accordingly.

When correctly set up, you can use your TV remote control to adjust the volume output (VOL +/- and MUTE) of the sound bar. - Connect the HDMI cable (not included) from unit's HDMI (ARC) socket to the HDMI (ARC) socket on your ARC compliant TV. Then press the remote control to select HDMI ARC mode.

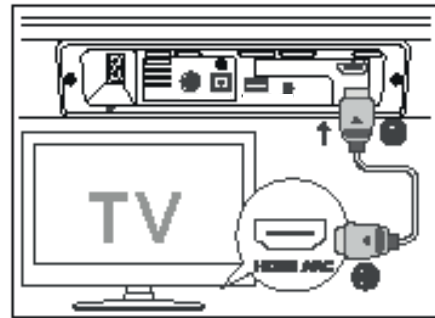

### NOTE

Your TV must support the HDMI-CEC and ARC and the HDMI-CEC and ARC must be set to On.

The setting method of HDMI-CEC and ARC may differ depending on the TV. For details about ARC function, please refer to the owner's manual.

Ensure that you use an HDMI cables that can support the ARC function.

HDMI-CEC will be called different names by various manufacturers – please refer to your owner's manual for details on setting up HDMI-CEC and ARC.

### Using the optical socket

The optical socket allows connection of the sound bar to the optical output of your TV or receiver. Simply connect using an optical (Toslink) cable. Remove the protective cap before connecting.



### Using the coaxial socket

The coaxial socket allows connection of the soundbar to the coaxial output of your TV or receiver. Simply connect using a 75 Ohm coaxial cable

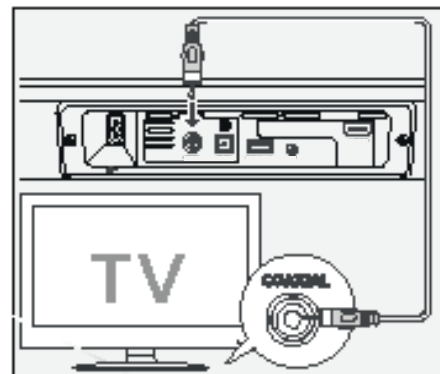

### Using the AUX socket

The AUX socket allows connection of the sound bar to any device with an unbalanced stereo line output, such as TV, computer, laptop, smartphone, tablet, ...

Depending of the output of the connected device 3.5 mm jack (A) or RCA (B), the appropriate cable shall be used.

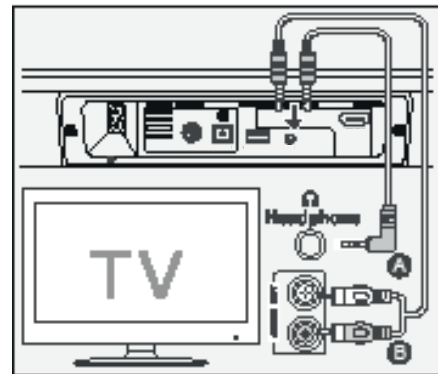

### Using Bluetooth

The first time when your Bluetooth portable device is connected (smartphone, tablet, ...) it needs to get paired. For getting it paired, the sound bar shall be switched ON and in Bluetooth mode. This can be done using the power button on the side of the unit, or the remote control. When in Bluetooth mode, the blue LED behind the front grill will blink. Activate the Bluetooth mode in your portable device and search for devices. The device name 'AUDAC IMEO2' will appear on your Bluetooth device list. If the device can't be found, press and hold the ► ■ ■ / PAIR button on the remote control to be discoverable. The system will enter in pairing mode and two 'beeps' will be heard through the speakers. The Bluetooth indicator (blue LED) will blink fast. Select 'AUDAC IMEO2' from the device list and an 'uplifting beep' will be heard through the speakers. The Bluetooth indicator (blue LED) will illuminate constantly.

#### BLUETOOTH

The Bluetooth® word mark and logos are registered trademarks owned by Bluetooth SIG, Inc. We are the licensee to use such marks. Other trademarks and trade names are those of their respective owners

#### NOTE

- The operation range between the sound bar device and the Bluetooth transmitter (smartphone, tablet, ... ) is approximately 8 meters. (without any object in between)
- Before any Bluetooth device is connected, ensure you know its capabilities
- Compatibility with all Bluetooth devices is not guaranteed
- Any obstacle in between the sound bar and the Bluetooth transmitter can reduce the operational range
- If the signal strength is weak, the sound bar will disconnect automatically, but will re-enter pairing mode automatically.



## Additional information

### UPDATE

Before updating the IMEO2, the new software must be obtained. This software can be found at <https://audac.eu/software>. The downloaded files, ending in .bfu, must be copied exactly to a USB stick.

Before the update can be carried out, the IMEO2 has to be switched to USB mode. The USB stick can be inserted into the USB port and the update will start automatically. All the lights will be on during the update process. When the update is completed the IMEO2 will automatically enter standby mode. The IMEO2 is now updated.

### DISABLE / ENABLE SPECIFIC FUNCTIONS

In projects with public system access such as classrooms or conference rooms, it can be desirable to lock it in a specific operation (input) mode or disable specific functions, to avoid users changing the input signal.

#### Lock input:

To lock the sound bar in a specific input function (disable the operation mode selection), turn the unit ON and switch to the desired audio source (e.g. AUX input). Press and hold the 'AUX' button (or other selected function) on the remote control for about 5 seconds to enable the lock. All status indicator LED's will blink now simultaneous and the input selection will be locked. (the input can't be changed by the user). Press and hold the selected function button again for about 5 seconds to disable the lock. All status indicator LED's will blink again simultaneous and the lock will be disabled.

#### Disable Bluetooth:

To disable the Bluetooth function, make sure the unit is in standby mode and press and hold the BT button on the remote control for about 5 seconds. The blue Bluetooth indicator LED will blink and the Bluetooth function will be disabled.

Press and hold the BT button again for about 5 seconds in standby mode to enable the Bluetooth function again. The blue Bluetooth indicator LED will blink and the Bluetooth function will be enabled again.

#### Disable auto standby:

To enable the auto standby function, make sure the unit is in standby mode and press and hold the power button on the remote control for about 5 seconds. The red indicator LED will flash 3 times and the auto standby function will be enabled.

To disable the auto standby function, make sure the unit is in standby mode and press and hold the power button on the remote control for about 5 seconds. The green indicator LED will flash 3 times and the auto standby function will be disabled.

#### Disable volume control on main unit:

To disable the volume control on the main unit, make sure the unit is in standby mode and press and hold "VOL+" and "VOL-" buttons on main unit. The green indicator LED will flash 3 times and the volume control will be disabled.

To enable the volume control on the main unit, make sure the unit is in standby mode and press and hold "VOL+" and "VOL-" buttons on main unit. The red indicator LED will flash 3 times and the volume control will be enabled.

## HOTEL MODE

In installations with multiple IMEO2's installed throughout the building, it can be desirable to assign custom Bluetooth ID's to distinguish them from each other. Typical applications are hotels, conference rooms, schools, ... The hotel mode function in the firmware offers a solution for these applications.

Using the hotel mode, the Bluetooth ID can be adjusted to 'AUDAC - IMEO2 + xxxx' where 'xxxx' is a 4-digit number, representing the room number, class number, meeting room number, ...

Additionally, a function is implemented to define a specific wake-up source, allowing the IMEO2 to always turn-on with the same input source selected, no matter which input source was selected before power-down.

To enable hotel mode, follow below steps:

### Enable hotel mode:

- Switch IMEO2 to standby mode (upper RED LED illuminated)
- Press code '6280' on remote control to enable hotel mode. (see image as below)  
(6280 = COAXIAL – BT – PAIR – VOL-)
- The green LED will start to blink (others are off)
- Enter the first number of the 4-digit ID (see image as below)
- The blue LED will start to blink (others are off)
- Enter the second number of the 4-digit ID (see image as below)
- The orange LED will start to blink (others are off)
- Enter the third number of the 4-digit ID (see image as below)
- The white LED will start to blink (others are off)
- Enter the fourth number of the 4-digit ID (see image as below)

After the 4 digits of the Bluetooth ID are entered, the upper (standby) LED will start to blink.

Now the wake-up input source can be selected with the last digit:

- 1: AUX
- 3: HDMI ARC
- 0: No specific wake up source

The BT name will now be changed to e.g. 'AUDAC IMEO2 – 1234' (in case 1234 was entered)

### Disable hotel mode:

To exit the hotel mode function, switch to standby mode and press the code '0826' on the remote control.

The red LED will flash 3 times.

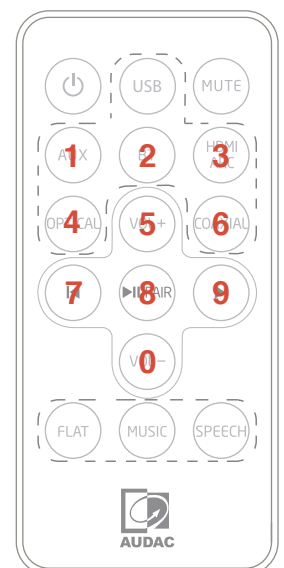

# Technical specifications



Inputs	Type	Stereo unbalanced line (AUX)
	Connectors	3.5mm jack connector
	Sensitivity	500 mV
	Type	Coaxial SP/DIF digital input
	Connectors	RCA
	Type	Optical SP/DIF digital input
	Connectors	Toslink
	Type	HDMI ARC
	Connectors	HDMI 19-pin
	Type	USB
	Connectors	USB-A
Output power		2 x 15 Watt RMS (Left & Right) 30 Watt RMS (Subwoofer)
Frequency response		40 Hz - 20 kHz
THD+N		1% (1 kHz, 1W)
Bluetooth	Version	V4.2
	Max power Tx	5 dBm
	Frequency band	2402 MHz- 2480 MHz
Remote control	Distance	6m
	Angle	30°
	Battery type	CR2025
Power consumption	Standby	0.5 Watt
	Nominal	30 Watt
Power supply		AC Input: 100-240V ~ 50/60Hz
Dimensions (WxHxD)		1000 x 60 x 113 mm
Weight		3.6 Kg
Packaging		Carton box
Shipping weight & volume		4.5 Kg - 0.022 Cbm
Accessories included		Remote control (IR)
		3.5 mm audio cable
		3.5 mm audio pigtail
		90° HDMI angle adapter
		Wall mounting bracket
		User manual



---

Discover more on [audac.eu](http://audac.eu)